

Type 107 Electrically Actuated Ball Valve

Standard Features

- **Size**
3/8" - 2"
- **Voltage**
24 AC or DC
110-230 AC
- **Emergency Manual Override**
- **Material**
PVC, CPVC
- **Connection Ends**
Socket, Flanged, Threaded NPT
- **Seat**
PTFE
- **Seals**
EPDM or FPM
- **Mounting**
Stainless steel threaded inserts
for easy and secure mounting
- **Duty Cycle**
40%

Optional Features

- **Pneumatic Actuation**
- **Limit Switches**
- **Fail Safe Return**
Back up battery pack
- **Heating Element**



General

Available in PVC and CPVC, the type 107 ball valve is ideal for a variety of applications. The type 107 valve is a perfect fit where simple open/close operation is required. It operates on either AC or DC voltage and has the option for position signalization limit switches. Included with each valve are NPT and Socket end connectors. Manual versions can easily be retrofitted in the field.

Technical specifications Electric actuator 11



CE	✓
SP	✓
UL US	✓

EA 11	
Nominal torque Mdn	10 Nm
Peak torque	20Nm
Control time	5 s/ 90° at Mdn
Actuating angle	max. 180°, set to 90°
L/W/H	129/122/138
Cycles at 70°F and Mdn	150,000
Flanges	F05
Housing materials	PP fiberglass reinforced, flame retardant, external stainless steel screws
Position indicator	optical, integrated
Emergency manual override	integrated
Rated voltage	100- 230V, 50/60 Hz 24V = /24V, 50/60 Hz
Rated voltage tolerance	+/- 10%
Rated output	28 Watts
Direct impedance	230V, 100k 24V, 4k7
Duty cycle ED	40% at 77°F/15 min
Protection class	IP 65 per EN 60529 [3] UL/CSA: for interior use
Overload protection	current / time dependent (resetting) [1]
Overvoltage category [5]	II
Electrical connections	Connector plug 3 P+ E per DIN EN 175301-03 (formerly DIN 43650), additional cable entry point for PG11
Pollution grade [5]	2
Height over NN (UL/CSA)	< 2000m
Ambient temperature	14° to + 110°F [2]
Allowable humidity	max. 80% to 88°F [4]

[1] Overload protection of the motor is dimensioned so that the motor and the power supply board are protected. As soon as the load is in the torque range, the actuator runs again.

[2] At temperatures below 14°F and if there is condensation, the heating element no. 198 190 086 should be built in.

[3] Protection class IP67 for use of cable glands and vertical installation.

[4] Linear decrease up to 50% relative humidity at 104°F.

[5] According to DIN EN 61010-1

Technical Data

Pressure-Temperature Diagrams Technical data for Type 107 Ball Valves 3/8"-2"

The following pressure temperature diagrams are based on a lifetime of 25 years and the medium water or similar media

PVC

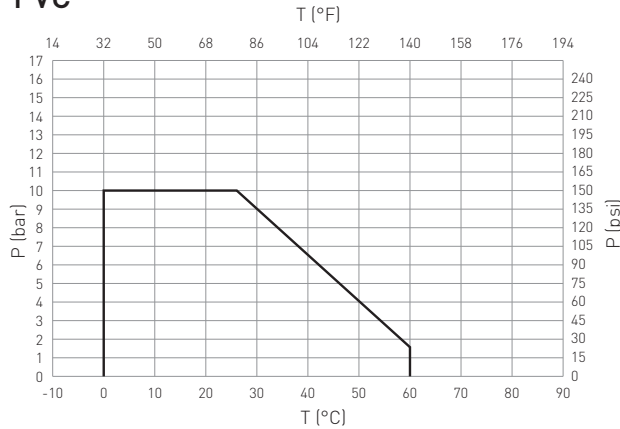

CPVC

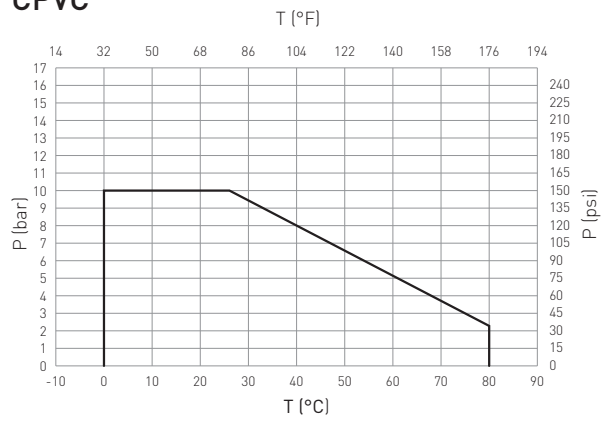

Operating Torque

Average values at nominal pressure

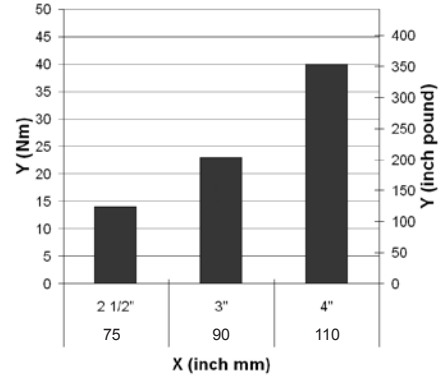
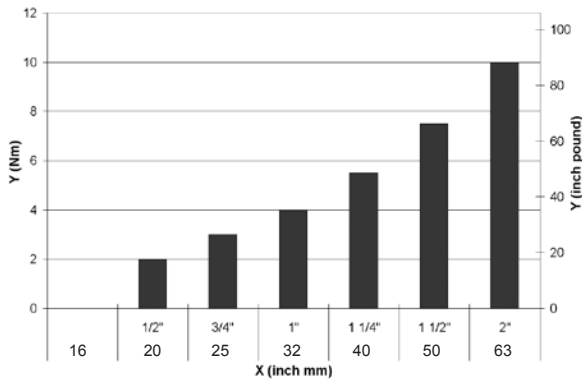

X Size (mm, inch) Y Torque (Nm, inch pound)

Pressure loss

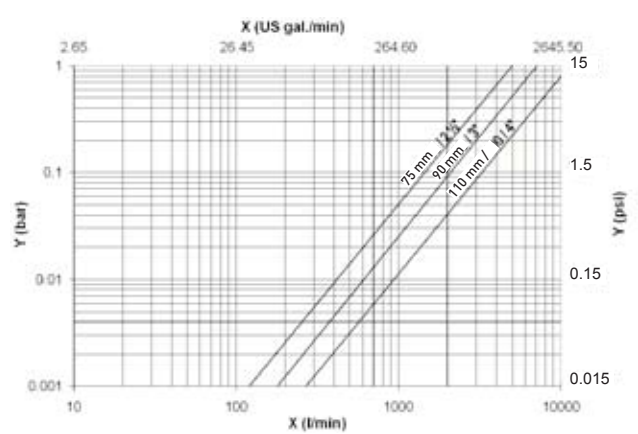
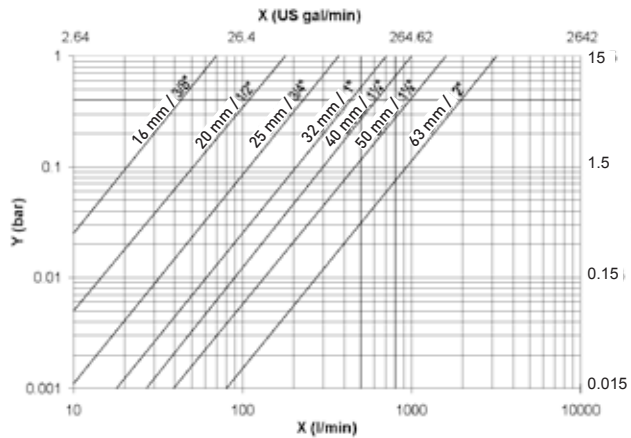

Medium: water, 20°C

X Flow rate (l/min / U.S. gal/min) Y Pressure loss Δp (bar / psi)

PVC

Type 107 Electrically Actuated Ball Valve

With manual emergency override

With solvent cement sockets inch ASTM/threaded NPT

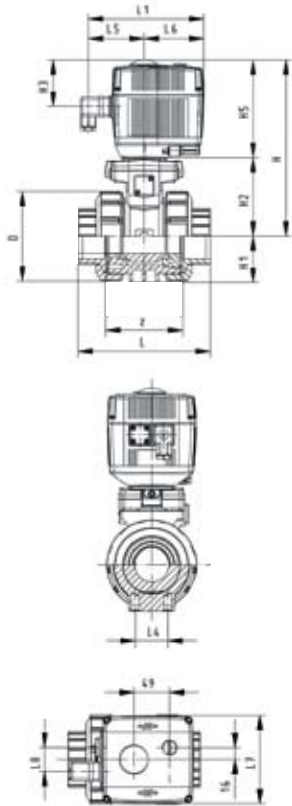

Inch	Cv-value [gal/min]	psi		D [mm]	H [mm]	H1 [mm]	H2 [mm]	H3 [mm]	H5 [mm]
		socket	NPT						
3/8	4.9	150	150	50	200	27	64	64	137
1/2	12.9	150	150	50	200	27	64	64	137
3/4	24.5	150	150	58	209	30	73	64	137
1	49.0	150	150	68	209	36	73	64	137
1 1/4	70.0	150	150	84	220	44	84	64	137
1 1/2	112.0	150	150	97	220	51	84	64	137
2	217.1	150	150	124	243	64	106	64	137

Sockets	L [mm]	L1 [mm]	L4 [mm]	L5 [mm]	L6 [mm]	L7 [mm]	L8 [mm]	z [mm]
	NPT							
105	98	161	25	79	83	122	67	67
105	98	161	25	79	83	122	67	61
121	111	161	25	79	83	122	67	70
133	127	161	25	79	83	122	67	76
154	147	161	45	79	83	122	67	90
164	157	161	45	79	83	122	67	94
183	183	161	45	79	83	122	67	107

With flanges, ANSI

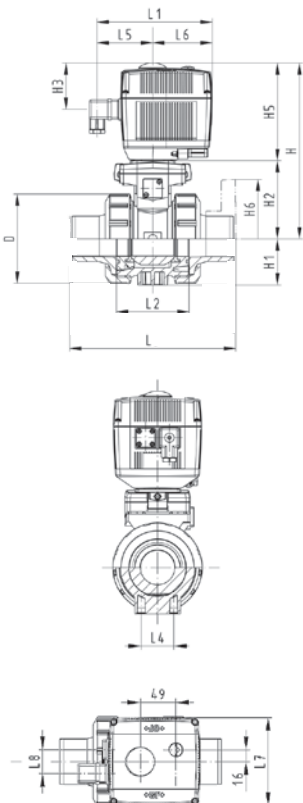

Inch	psi	Cv-value [gal/min]	D [mm]	H [mm]	H1 [mm]	H2 [mm]	H3 [mm]	H5 [mm]	L [mm]
1/2	150	12.9	50	200	27	64	64	137	149
3/4	150	24.5	58	209	30	73	64	137	165
1	150	49.0	68	209	36	73	64	137	184
1 1/4	150	70.0	84	220	44	84	64	137	206
1 1/2	150	112.0	97	220	51	84	64	137	221
2	150	217.0	124	243	64	106	64	137	251

L1 [mm]	L2 [mm]	L4 [mm]	L5 [mm]	L6 [mm]	L7 [mm]	L8 [mm]
161	56	25	77	83	122	33
161	65	25	77	83	122	33
161	71	25	77	83	122	33
161	85	45	77	83	122	33
161	89	45	77	83	122	33
161	101	45	77	83	122	33

CPVC

Type 107 Electrically Actuated Ball Valve

With solvent cement sockets inch ASTM/threaded NPT

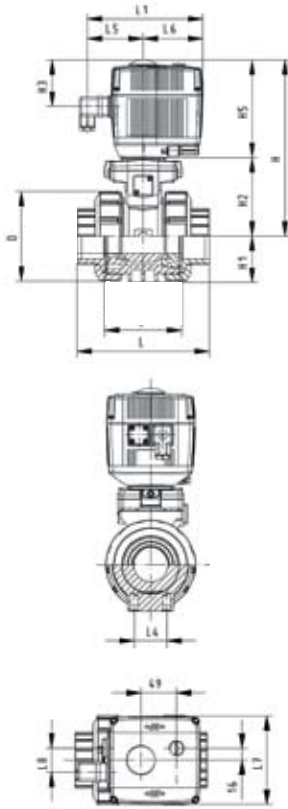

Inch	Cv-value [gal/min]	psi		D [mm]	H [mm]	H1 [mm]	H2 [mm]	H3 [mm]	H5 [mm]
		socket	NPT						
3/8	4.9	150	150	50	200	27	64	64	137
1/2	12.9	150	150	50	200	27	64	64	137
3/4	24.5	150	150	58	209	30	73	64	137
1	49.0	150	150	68	209	36	73	64	137
1 1/4	70.0	150	150	84	220	44	84	64	137
1 1/2	112.0	150	150	97	220	51	84	64	137
2	217.1	150	150	124	243	64	106	64	137

Socket	L [mm]	L1 [mm]	L4 [mm]	L5 [mm]	L6 [mm]	L7 [mm]	L8 [mm]	z [mm]
	NPT							
105	98	161	25	79	83	122	67	67
105	98	161	25	79	83	122	67	61
121	111	161	25	79	83	122	67	70
133	127	161	25	79	83	122	67	76
154	147	161	45	79	83	122	67	90
164	157	161	45	79	83	122	67	94
183	183	161	45	79	83	122	67	107

GF Piping Systems → worldwide at home

Our sales companies and representatives ensure local customer support in over 100 countries.

www.piping.georgfischer.com



The technical data is not binding. They neither constitute expressly warranted characteristics nor guaranteed properties nor a guaranteed durability. They are subject to modification. Our General Terms of Sale apply.

Adding Quality to People's Lives

Australia

Georg Fischer Pty Ltd
Riverwood NSW 2210 Australia
Phone +61(0)2 9502 8000
australia.ps@georgfischer.com
www.georgfischer.com.au

Austria

Georg Fischer
Rohrleitungssysteme GmbH
3130 Herzogenburg
Phone +43(0)2782 856 43-0
austria.ps@georgfischer.com
www.georgfischer.at

Belgium/Luxembourg

Georg Fischer NV/SA
1070 Bruxelles/Brüssel
Phone +32(0)2 556 40 20
be.ps@georgfischer.com
www.georgfischer.be

Brazil

Georg Fischer Ltda
04795-100 São Paulo
Phone +55(0)11 5687 1311
br.ps@georgfischer.com

Canada

Georg Fischer Piping Systems Ltd
Brampton, ON L6T 4E3
Phone +1(905) 792-8005
ca.ps@georgfischer.com
www.gfipiping.ca

China

Georg Fischer
Piping Systems Ltd Shanghai
Pudong, Shanghai 201319
Phone +86(0)21 58 13 33 33
china.ps@georgfischer.com
www.cn.piping.georgfischer.com

Denmark/Iceland

Georg Fischer A/S
2630 Taastrup
Phone +45 (0)70 22 19 75
info.dk.ps@georgfischer.com
www.georgfischer.dk

France

Georg Fischer SAS
95932 Roissy Charles de Gaulle Cedex
Phone +33(0)1 41 84 68 84
fr.ps@georgfischer.com
www.georgfischer.fr

Germany

Georg Fischer GmbH
73095 Albershausen
Phone +49(0)7161 302-0
info.de.ps@georgfischer.com
www.georgfischer.de

India

Georg Fischer Piping Systems Ltd
400 076 Mumbai
Phone +91 224007 2001
in.ps@georgfischer.com
www.georgfischer.in

Italy

Georg Fischer S.p.A.
20063 Cernusco S/N (MI)
Phone +3902 921 861
it.ps@georgfischer.com
www.georgfischer.it

Japan

Georg Fischer Ltd
556-0011 Osaka
Phone +81(0)6 6635 2691
jp.ps@georgfischer.com
www.georgfischer.jp

Korea

Georg Fischer Piping Systems
Guro-3 dong, Guro-gu, Seoul, Korea
Phone +82(0)2 2081 1450
Fax +82(0)2 2081 1453
kor.ps@georgfischer.com

Malaysia

Georg Fischer (M) Sdn. Bhd.
40460 Shah Alam, Selangor
Phone +60 (0)3 5122 5585
conne.kong@georgfischer.com

Mexico

Georg Fischer S.A. de C.V.
Apodaca, Nuevo Leon
CP66636 Mexico
Phone +52 (81)1340 8586
Fax +52 (81)1522 8906

Middle East

Georg Fischer Piping Systems
Dubai, United Arab Emirates
Phone +971 4 289 49 60
info.export@georgfischer.com
www.export.georgfischer.com

Netherlands

Georg Fischer N.V.
8161 PA Epe
Phone +31(0)578 678 222
nL.ps@georgfischer.com
www.georgfischer.nl

Norway

Georg Fischer AS
1351 Rud
Phone +47(0)67 18 29 00
no.ps@georgfischer.com
www.georgfischer.no

Poland

Georg Fischer Sp. z o.o.
02-226 Warszawa
Phone +48(0)22 313 10 50
poland.ps@georgfischer.com
www.georgfischer.pl

Romania

Georg Fischer
Piping Systems Ltd
020257 Bucharest - Sector 2
Phone +40(0)21 230 53 80
ro.ps@georgfischer.com
www.export.georgfischer.com

Russia

Georg Fischer Piping Systems
Moscow 125047
Tel. +7 495 258 60 80
ru.ps@georgfischer.com
www.georgfischer.ru

Singapore

Georg Fischer Pte Ltd
528 872 Singapore
Phone +65(0)67 47 06 11
sgp.ps@georgfischer.com
www.georgfischer.com.sg

Spain/Portugal

Georg Fischer S.A.
28046 Madrid
Phone +34(0)91 781 98 90
es.ps@georgfischer.com
www.georgfischer.es

Sweden/Finland

Georg Fischer AB
12523 Älvsjö-Stockholm
Phone +46(0)8 506 775 00
info.se.ps@georgfischer.com
www.georgfischer.se

Switzerland

Georg Fischer
Rohrleitungssysteme [Schweiz] AG
8201 Schaffhausen
Phone +41(0)52 631 30 26
ch.ps@georgfischer.com
www.piping.georgfischer.ch

Taiwan

Georg Fischer Piping Systems
San Chung City, Taipei Hsien
Phone +886 2 8512 2822
Fax +886 2 8512 2823

United Kingdom/Ireland

Georg Fischer Sales Limited
Coventry, CV2 2ST
Phone +44(0)2476 535 535
uk.ps@georgfischer.com
www.georgfischer.co.uk

USA/Latin America/Caribbean

Georg Fischer LLC
Tustin, CA 92780-7258
Phone +1(714) 731 88 00
Toll Free 800 854 40 90
us.ps@georgfischer.com
www.us.piping.georgfischer.com